

# **SHOOTY- RÄTSELSPASS**

# 4



**FASZINATION LICHTSCHIESSEN IM **



# SHOOTY-RÄTSELSPASS

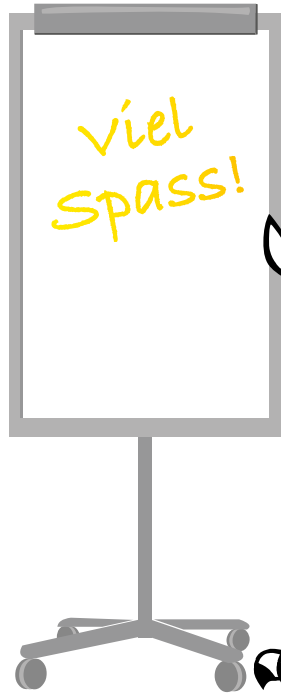

Gib den Shootys ein paar  
mehr Farben.



# SHOOTY-RÄTSELSPASS

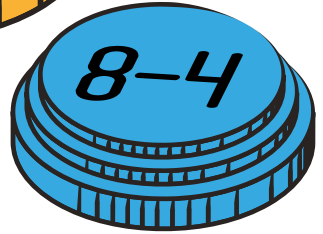
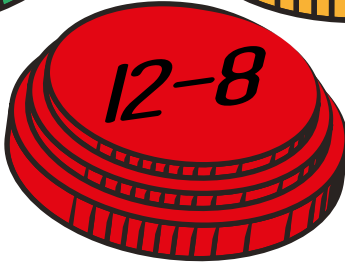
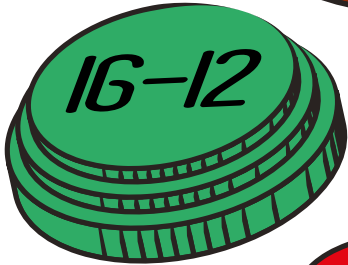
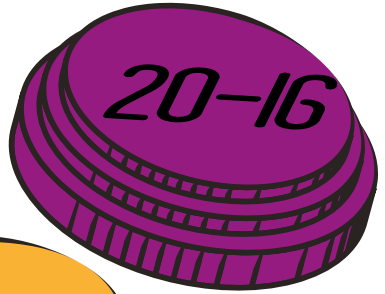
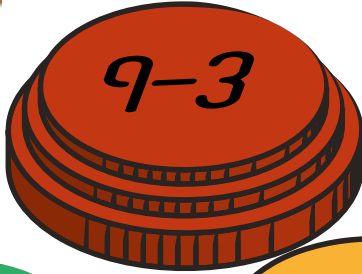

Welcher Shooty schießt  
welche Tonscheibe ab?  
Ziehe Linien.



# SHOOTY-RÄTSELSPASS

Welcher Schütze hat die meisten Ringe?

A

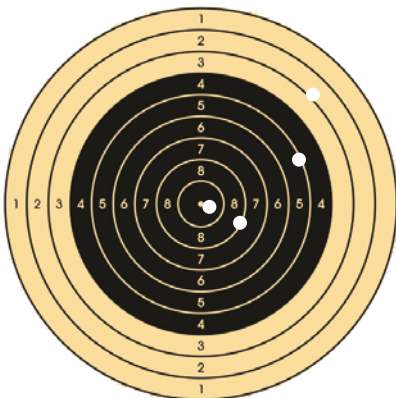

B



C



D



Lösung: \_\_\_\_\_



# SHOOTY-RÄTSELSPASS

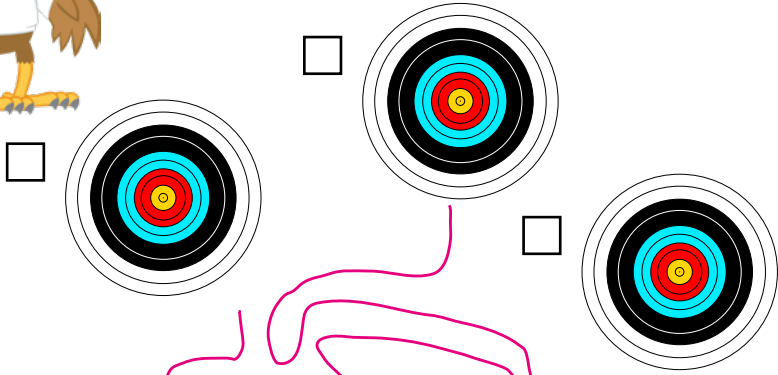

Welche Zielscheibe trifft Shooty?



# SHOOTY-RÄTSELSPASS

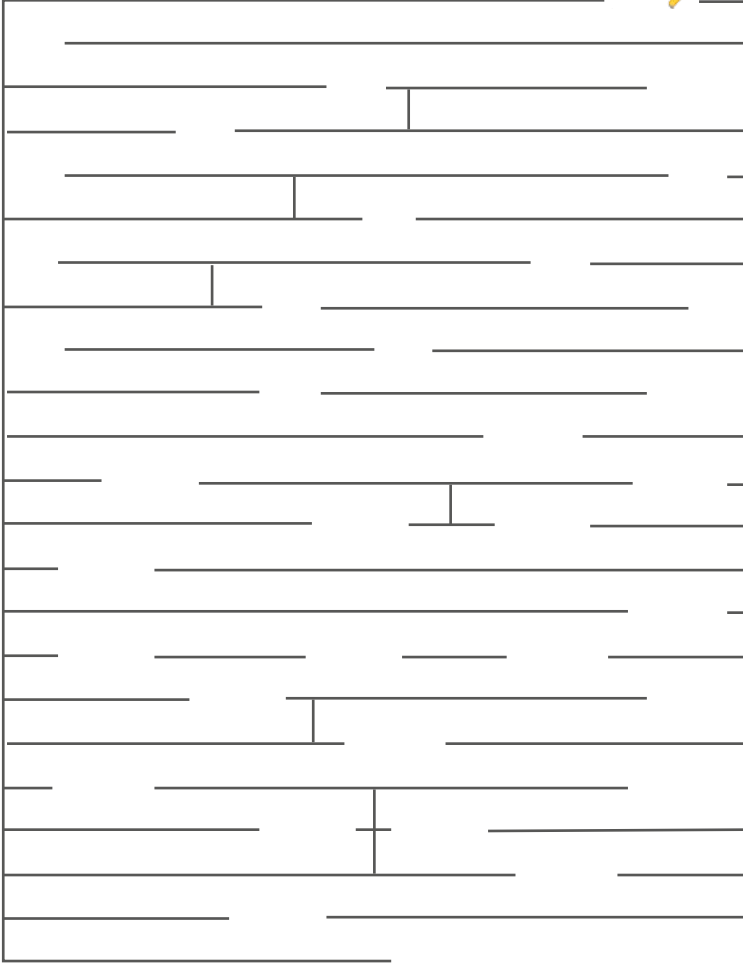

Hilf Shooty, den Weg zur Zielscheibe zu finden.





# SHOOTY-RÄTSELSPASS

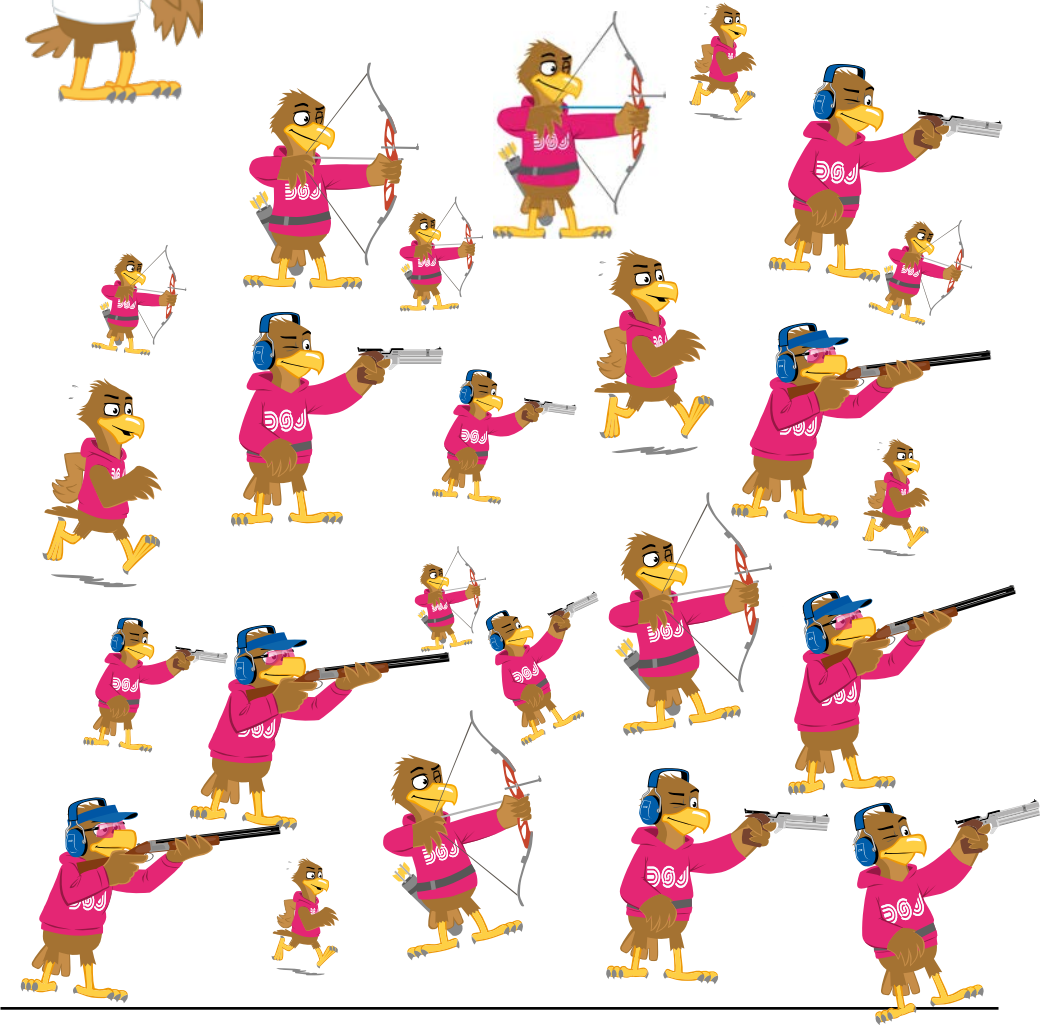

Zähle die verschiedenen Shootys

LÖSUNG:



LÖSUNG:



LÖSUNG:



LÖSUNG:





# SHOOTY-RÄTSELSPASS

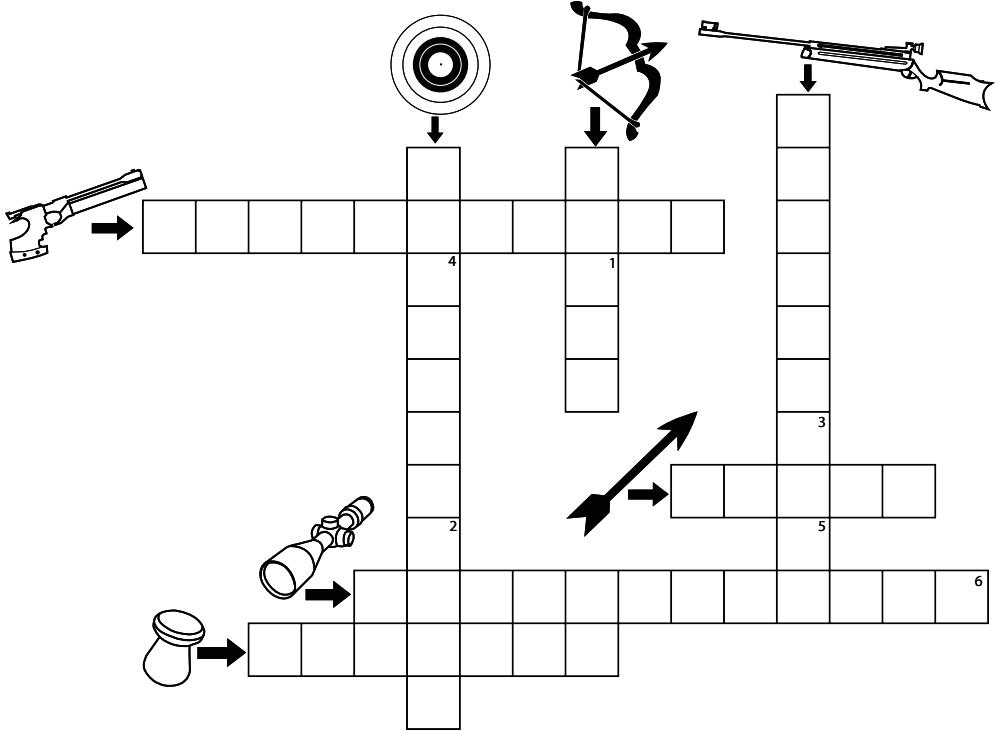

Finde das Lösungswort.

--	--	--	--	--	--

1 2 3 4 5 6





# SHOOTY-RÄTSELSPASS

Hilf Shooty die richtige Zielscheibe zu treffen.

Verbinde die Punkte.





# SHOOTY-RÄTSELSPASS

Hilf Shooty den Weg zur Faszination  
Lichtschießen zu finden!  
Weiche den bunten Hindernissen aus.

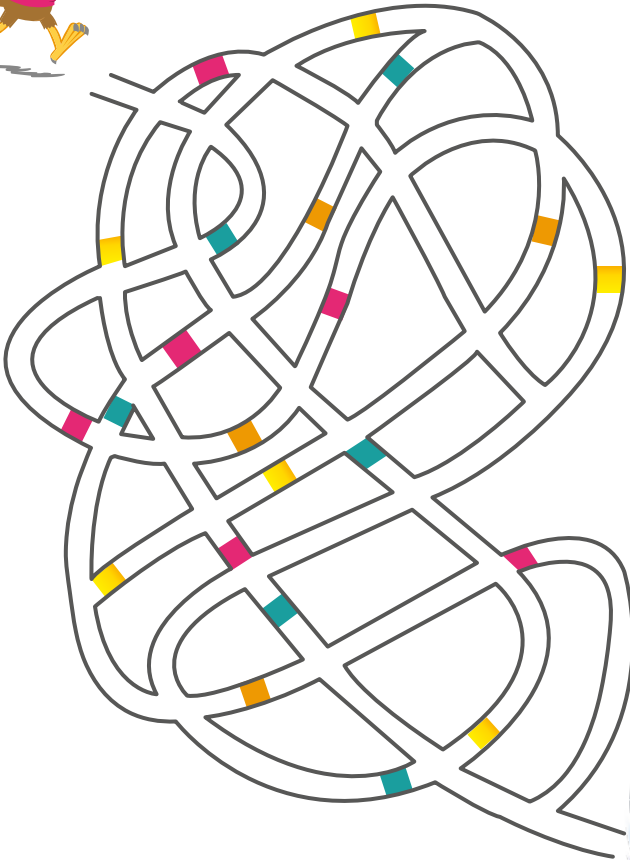



# SHOOTY-RÄTSELSPASS

Bist du ein großer Shootyfan?  
Dann ist dieses Rätsel sicher kein Problem für dich.

**Welche Körperteile gehören wo hin?**

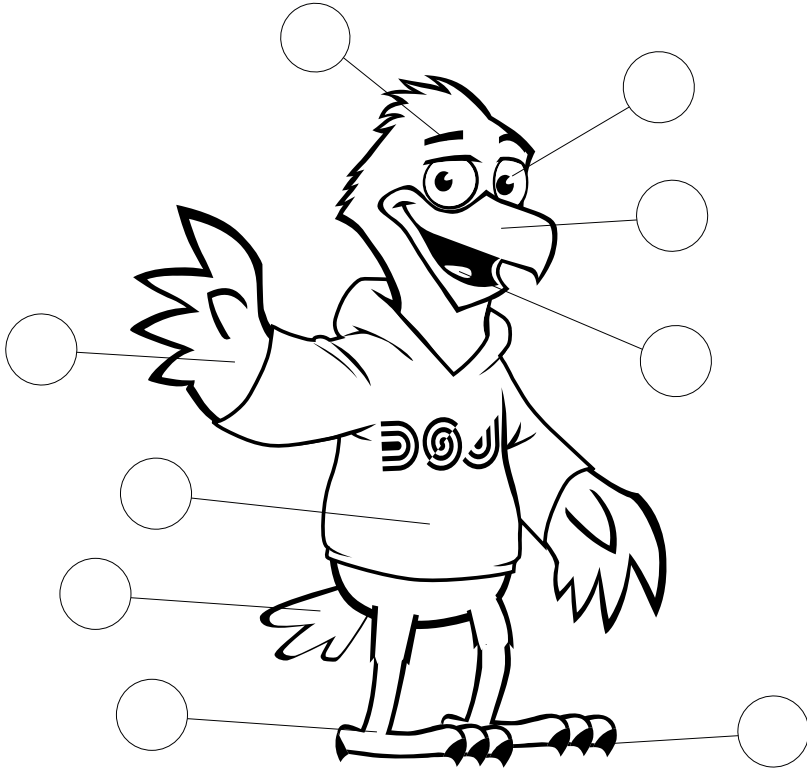

- 1 - Schnabel
- 2 - Krallen
- 3 - Augenbraue

- 4 - Flügel
- 5 - Auge
- 6 - Bauch

- 7 - Schwanz
- 8 - Zunge
- 9 - Fuß



# SHOOTY-RÄTSELSPASS

Hilf Shooty seinen Schatten zu finden.

Verbinde die Punkte.





# SHOOTY-RÄTSELSPASS

Hilf Shooty die Zielscheibe zu treffen.

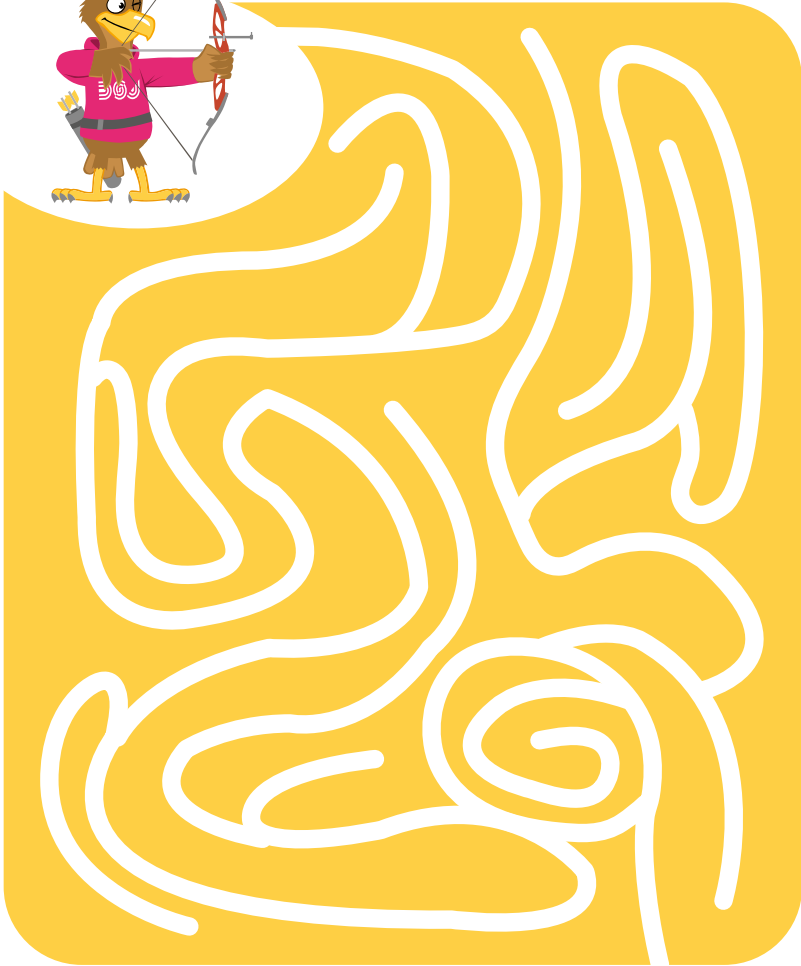



# SHOOTY-RÄTSELSPASS

Versuche die Rechenaufgabe zu lösen

$$\text{Bird} + \text{Bird} = 18$$

$$\text{Bird} + \text{Bird with Shotgun} - \text{Bird} = 11$$

$$\text{Bird with Shotgun} + \text{Bird} - \text{Bird with Pistol} = 18$$

$$\text{Bird with Shotgun} + \text{Bird with Pistol} - \text{Bird with Pistol} = \text{Bird}$$

$$\text{Bird with Pistol} = ?$$

Lösung



# SHOOTY-RÄTSELSPASS

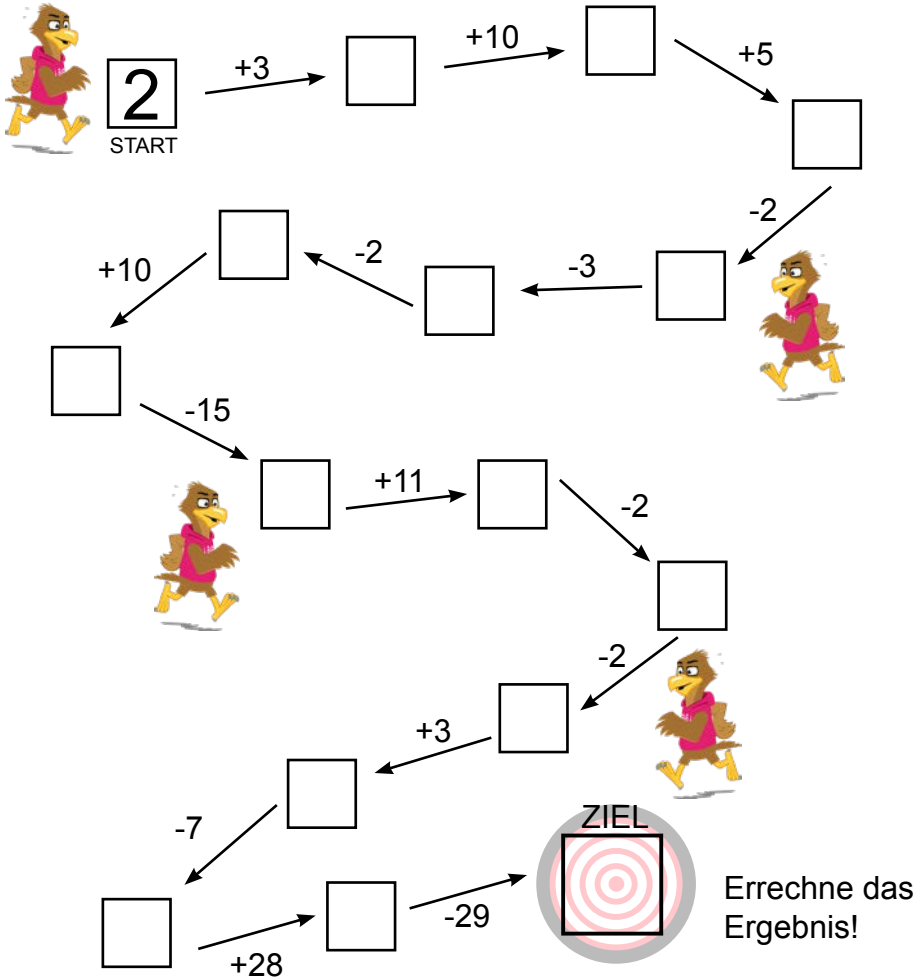



# SHOOTY-RÄTSELSPASS

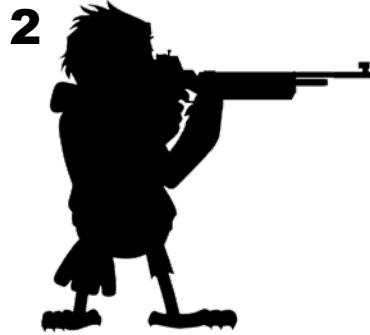
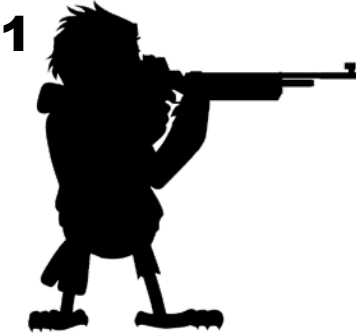

Welche der beiden  
Schatten sind gleich?

LÖSUNG: \_\_\_\_\_





# SHOOTY-RÄTSELSPASS

Löse das Shooty-Bildersudoku.

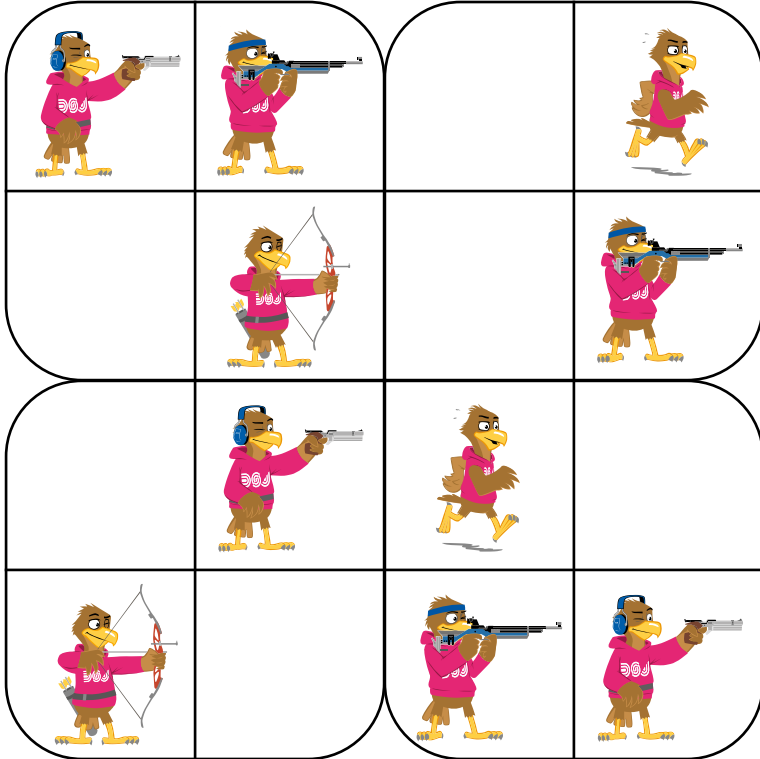

1



2



3



4





# SHOOTY-RÄTSELSPASS

Hilf Shooty den Weg zur Zielscheibe zu finden.

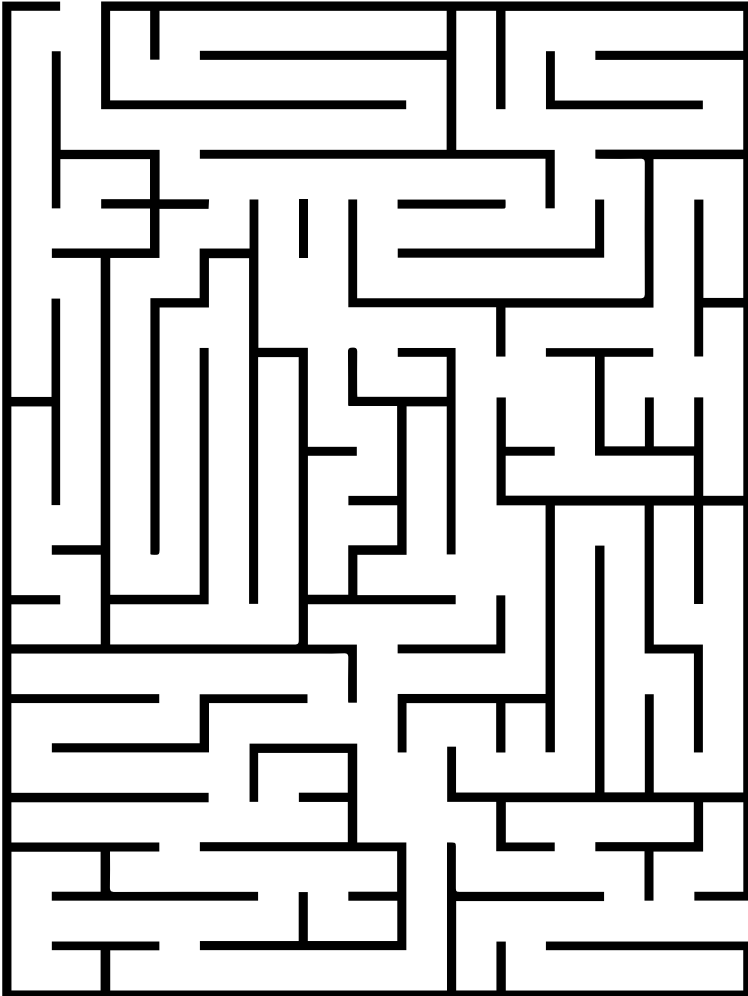

# Notizen



Gesamtverantwortlich  
Stefan Rinke (Vizepräsident Jugend, DSB)

Verantwortlich für den Inhalt  
Deutsche SchützenJugend

Druck und Papier  
Wiesbaden 2023



Deutsche SchützenJugend  
Lahnstraße 120  
65195 Wiesbaden

Fon +49 (0) 611 - 46807 421  
Fax +49 (0) 611 - 46807 460  
Mail jugend@dsb.de

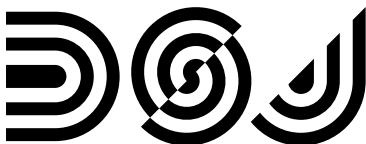

Deutsche  
SchützenJugend

[www.dsj-dsb.de](http://www.dsj-dsb.de)

**FASZINATION LICHTSCHIESSEN IM **