

SHOOTY- RÄTSELSPASS



FASZINATION LICHTSCHIESSEN IM 



SHOOTY-RÄTSELSPASS

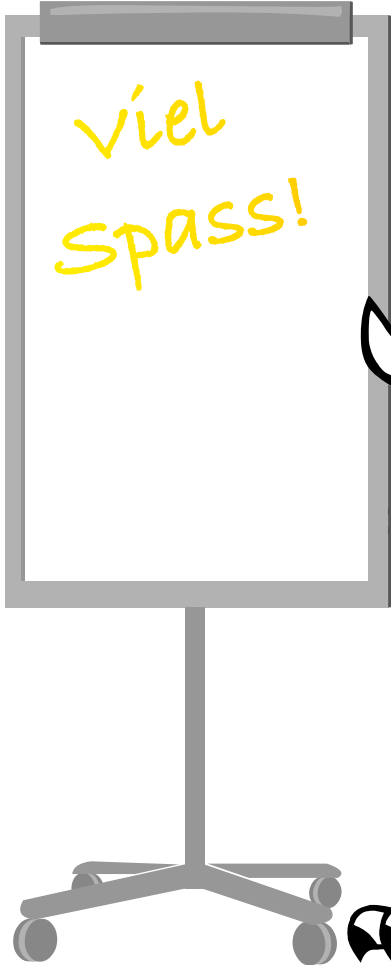

Gib Shooty ein paar
mehr Farben.



SHOOTY-RÄTSELSPASS



Welche der beiden
Schatten sind gleich?

LÖSUNG: _____



SHOOTY-RÄTSELSPASS



Gib Shooty ein paar
mehr Farben.



SHOOTY-RÄTSELSPASS

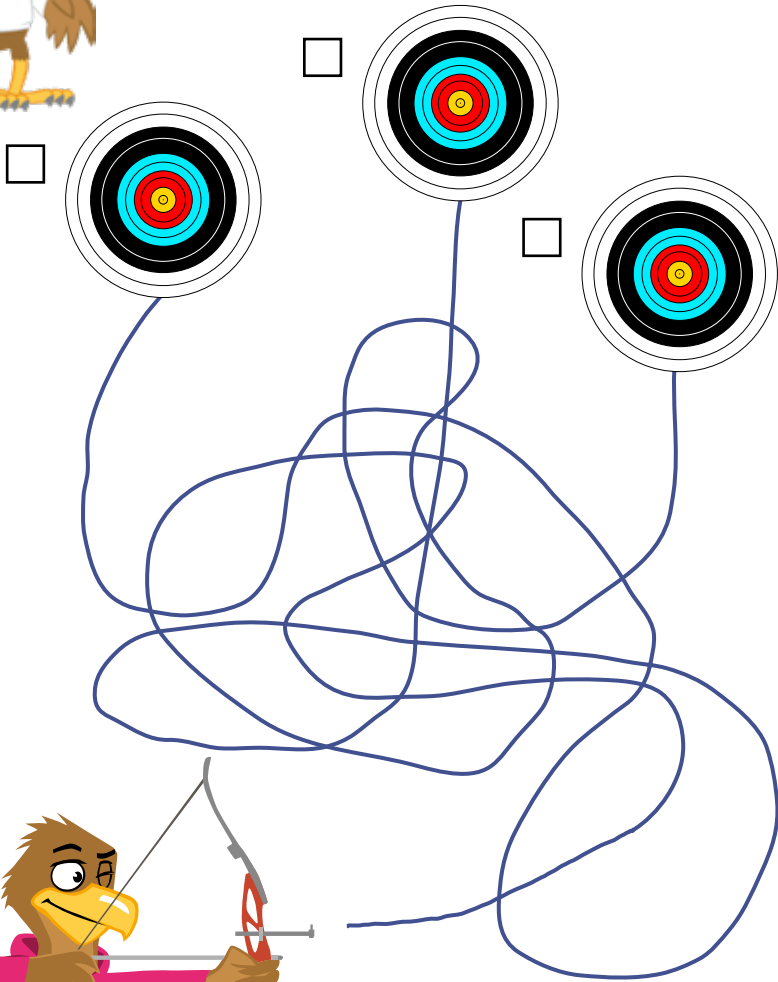

Welche Zielscheibe trifft Shooty?



SHOOTY-RÄTSELSPASS

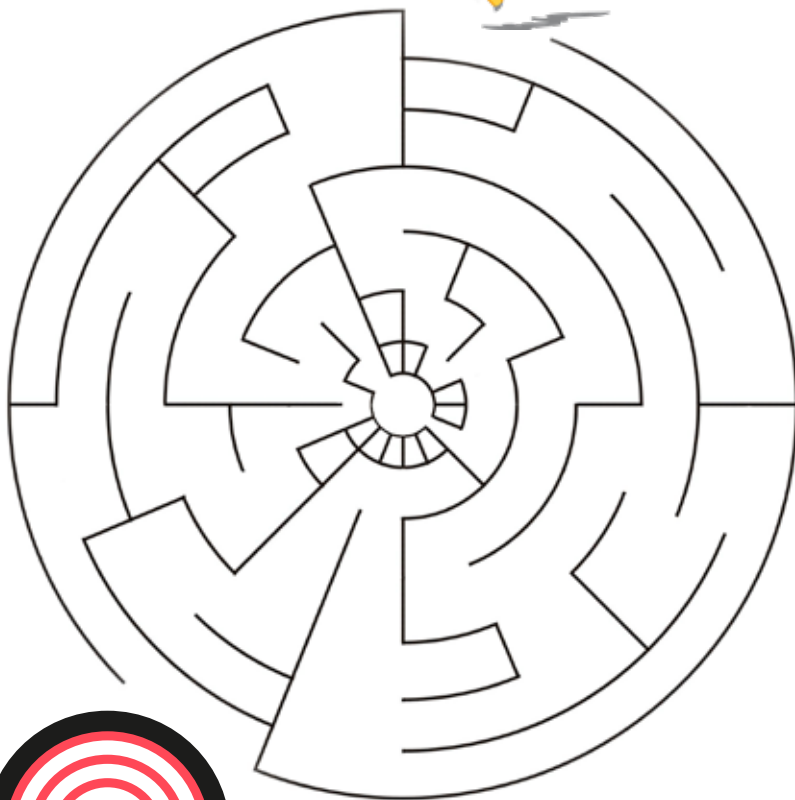

Hilf Shooty den Weg zur Zielscheibe zu finden.



SHOOTY-RÄTSELSPASS

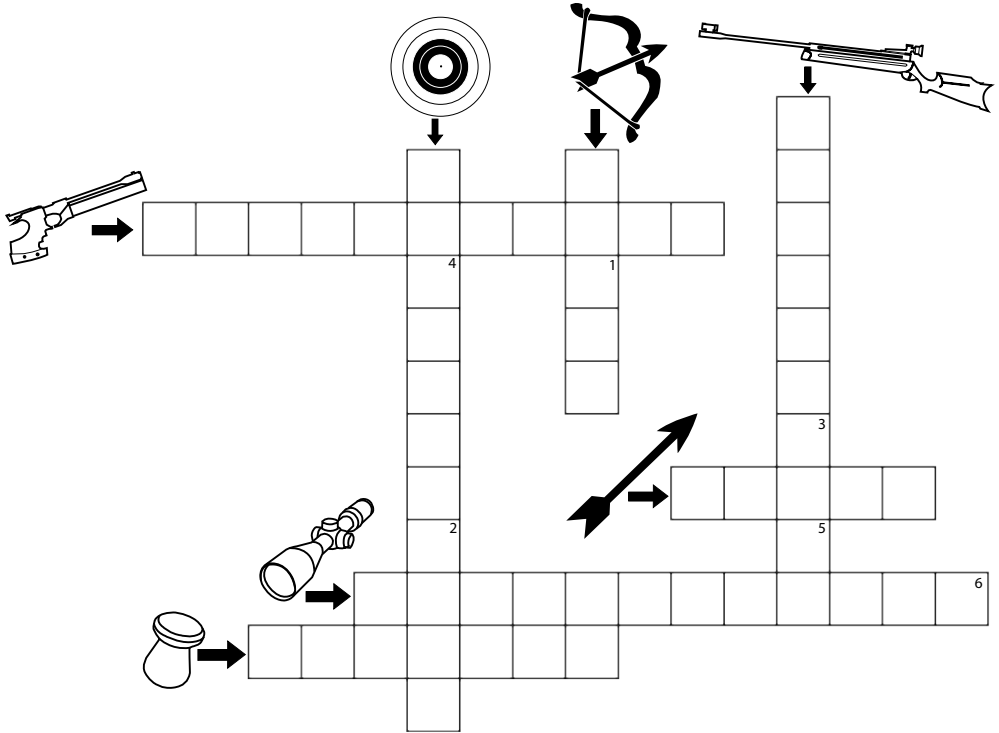

Finde das Lösungswort.

| | | | | | |
|--|--|--|--|--|--|
| | | | | | |
|--|--|--|--|--|--|

1 2 3 4 5 6

SHOOTY-RÄTSELSPASS



Findest Du die sieben Fehler zwischen den beiden Bildern?



SHOOTY-RÄTSELSPASS

Verbinde die Punkte in der richtigen Reihenfolge.

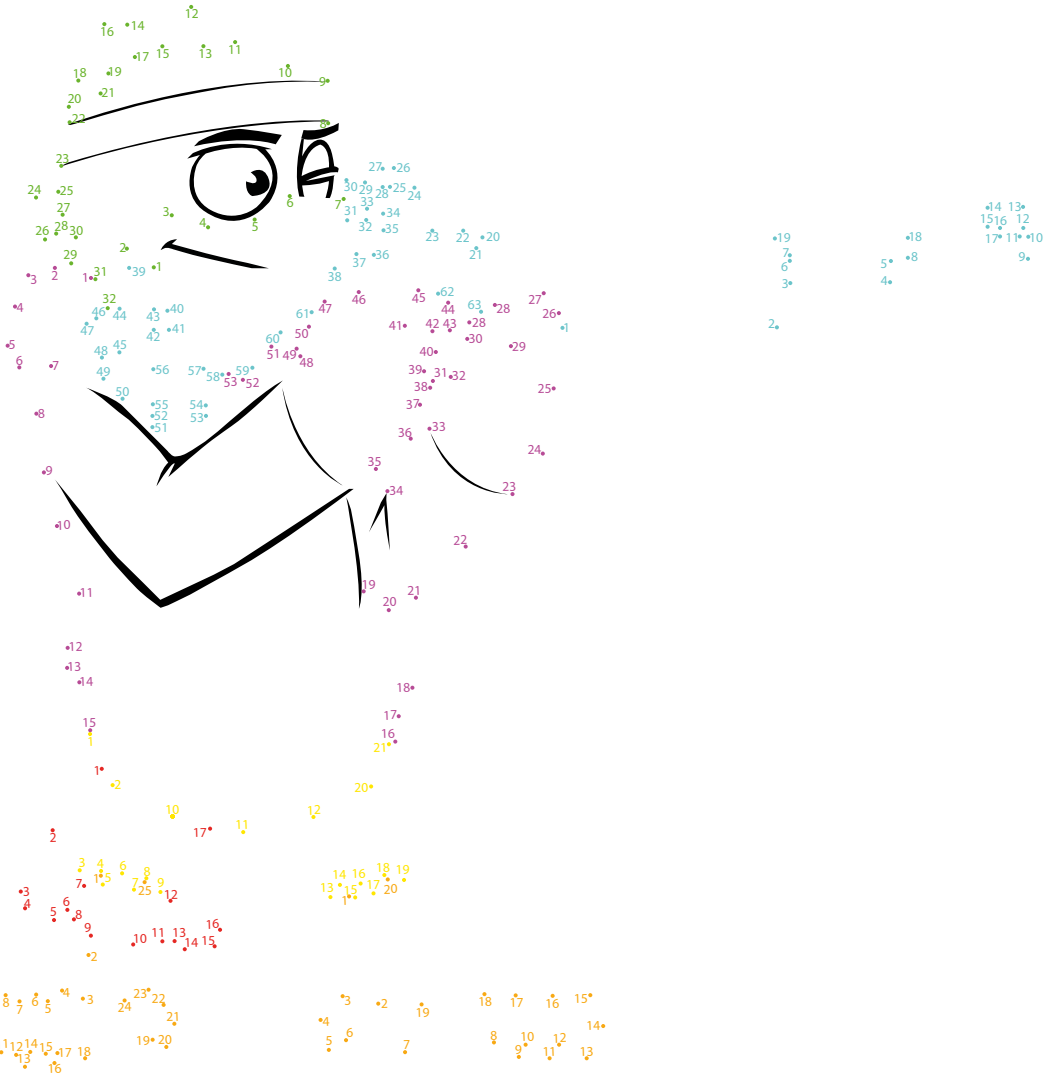

Was verbirgt sich hinter den Punkten?



SHOOTY-RÄTSELSPASS

Welcher Schütze hat die meisten Ringe?

A



B



C



D



SHOOTY-RÄTSELSPASS



Zähle die verschiedenen Shootys

LÖSUNG:



LÖSUNG:



LÖSUNG:



LÖSUNG:





SHOOTY-RÄTSELSPASS

Versuche die Rechenaufgabe zu lösen

$$\text{Bird} + \text{Bird} = 18$$

$$\text{Bird} + \text{Bird} - \text{Archery Bird} = 11$$

$$\text{Archery Bird} \times \text{Bird} + \text{Gun Bird} = 80$$

$$\text{Gun Bird} - \text{Archery Bird} - \text{Gun Bird} = \text{Bird}$$

$$\text{Gun Bird} = \underline{\hspace{2cm}} ?$$



SHOOTY-RÄTSELSPASS

Finde 5 Wörter und umkreise sie.
Die Wörter können waagrecht und senkrecht angeordnet sein.

| | | | | | | | | | | | | | | |
|---|---|---|---|---|---|---|---|---|---|---|---|---|---|---|
| J | H | U | J | D | Ü | S | G | Z | C | D | A | A | Ä | H |
| T | G | D | Q | W | L | H | F | I | Z | K | A | D | E | R |
| C | V | P | I | S | T | O | L | E | S | Q | W | P | Z | T |
| H | F | D | L | K | X | O | H | L | G | D | Z | G | C | S |
| T | F | S | P | O | R | T | L | S | V | R | G | P | G | O |
| S | D | O | J | T | A | Y | X | C | G | E | F | D | E | K |
| U | G | H | J | H | C | F | F | H | I | A | Ü | Ö | W | H |
| R | J | U | G | E | N | D | X | E | L | L | Z | F | E | V |
| P | I | Z | F | R | E | S | F | I | O | O | I | D | H | E |
| E | Z | U | D | F | G | G | R | B | O | G | E | N | R | R |
| M | N | S | C | H | Ü | T | Z | E | G | F | L | N | N | E |
| E | Z | Q | Ü | P | J | H | H | D | F | X | R | Y | Ü | I |
| S | G | F | R | H | I | O | G | D | I | H | O | D | H | N |
| A | M | U | N | I | T | I | O | N | Ü | P | H | D | E | W |
| G | Q | R | L | J | F | U | H | D | H | W | R | R | T | H |



SHOOTY-RÄTSELSPASS

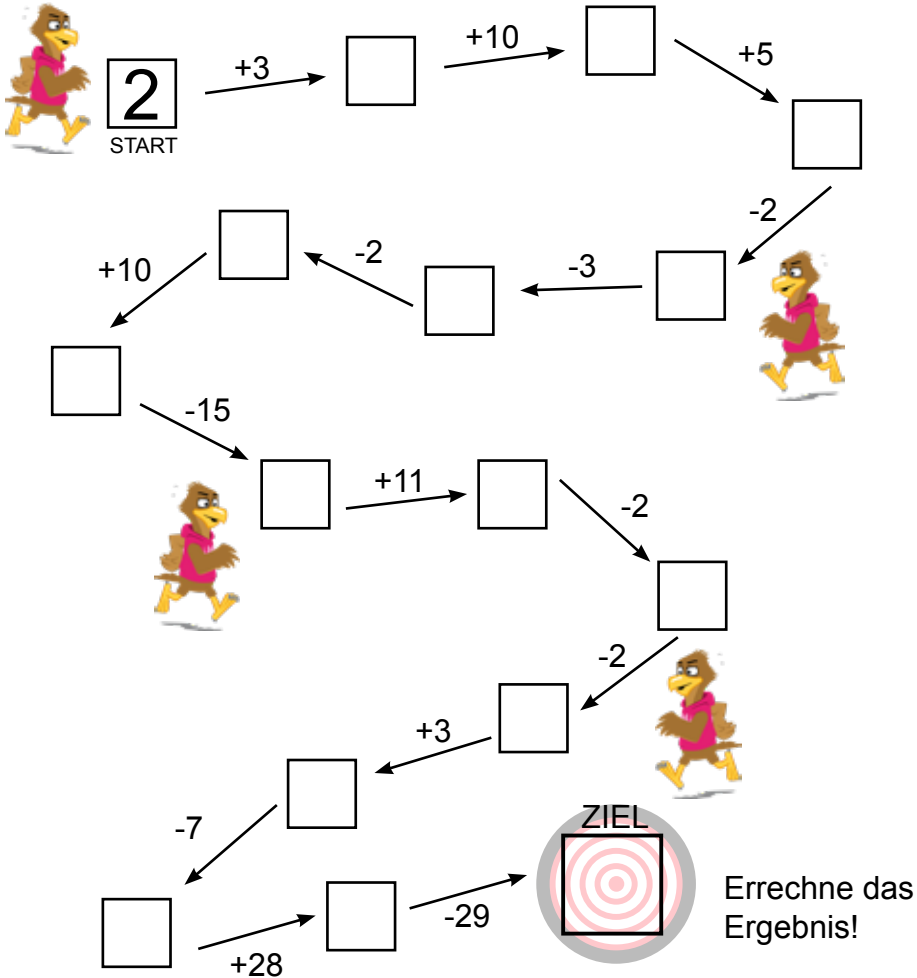



SHOOTY-RÄTSELSPASS



Findest Du die sieben Fehler zwischen den beiden Bildern?



SHOOTY-RÄTSELSPASS

Sudoku (leicht)

| | | | | | | | | |
|---|---|---|---|---|---|---|---|---|
| | | 6 | | | 5 | | | |
| | | 7 | 8 | 4 | | 9 | | |
| 8 | | | 6 | 3 | | | | |
| 7 | | | | 9 | 1 | 5 | | |
| | 8 | 3 | 2 | 5 | | 1 | | |
| 1 | 5 | 9 | | | 6 | 4 | 3 | 2 |
| | 6 | 5 | | | 9 | | 2 | 3 |
| 3 | | 2 | 5 | | 8 | | 9 | 4 |
| | | | | | 3 | 6 | 5 | 1 |

© RateFUX 2018-338-001



SHOOTY-RÄTSELSPASS

Hilf Shooty den Weg zur
Zielscheibe zu finden.

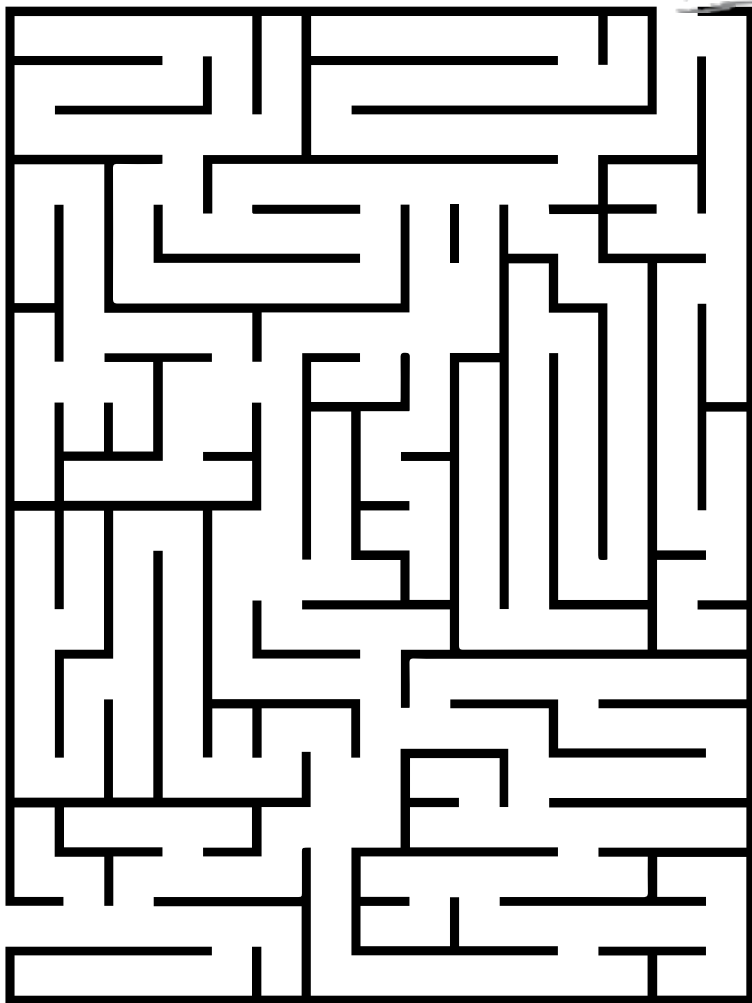



SHOOTY-RÄTSELSPASS

Gib Shooty ein paar
mehr Farben.



FASZINATION LICHTSCHIESSEN IM



Notizen



Gesamtverantwortlich
Stefan Rinke (Vizepräsident Jugend, DSB)

Verantwortlich für den Inhalt
Deutsche SchützenJugend

Druck und Papier Xpert-print
Wiesbaden, 2018

Deutsche SchützenJugend
Lahnstraße 120
65195 Wiesbaden

Fon +49 (0) 611 - 46807 21
Fax +49 (0) 611 - 46807 60
Mail jugend@dsb.de

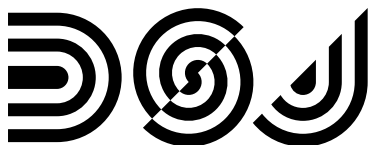

Deutsche
SchützenJugend

www.dsj-dsb.de

Hier könnte Ihr Logo stehen